

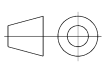

DO NOT SCALE DRAWING SHEET 1 OF 3	WEIGHT: 8955.41		 <b>Rank Steel A/S</b> Industrivej 23 - 6900 Skjern - Denmark <a href="http://www.ranksteel.com">www.ranksteel.com</a>
	DRAWN	CHECKED	
UNLESS OTHERWISE SPECIFIED: DIMENSIONS ARE IN MILLIMETERS TOLERANCES: LINEAR: According to ANGULAR: DIN 7168-g	NAME	DATE	TITLE:
	Processes: welding shop prime		Corner connector plate w. bolts (50)
<b>PROPRIETARY AND CONFIDENTIAL</b> THE INFORMATION CONTAINED IN THIS DRAWING IS THE SOLE PROPERTY OF RANK STEEL A/S. ANY REPRODUCTION IN PART OR AS A WHOLE WITHOUT THE WRITTEN PERMISSION OF RANK STEEL A/S IS PROHIBITED.	Remarks:		DWG NO. 900800
			REVISION 4

ITEM NO.	QTY.	PART NO.	REVISION	DESCRIPTION	DIN-ISO	REMARKS
1	1	801230	1	Corner connector plate (50)		
2	4	801270	0	Bolt reinforcement		
3	2	800320	0	M20x60	DIN 933	8.8 - untreated
4	2	800350	0	M20 nut	DIN 934	8.8 - galvanized

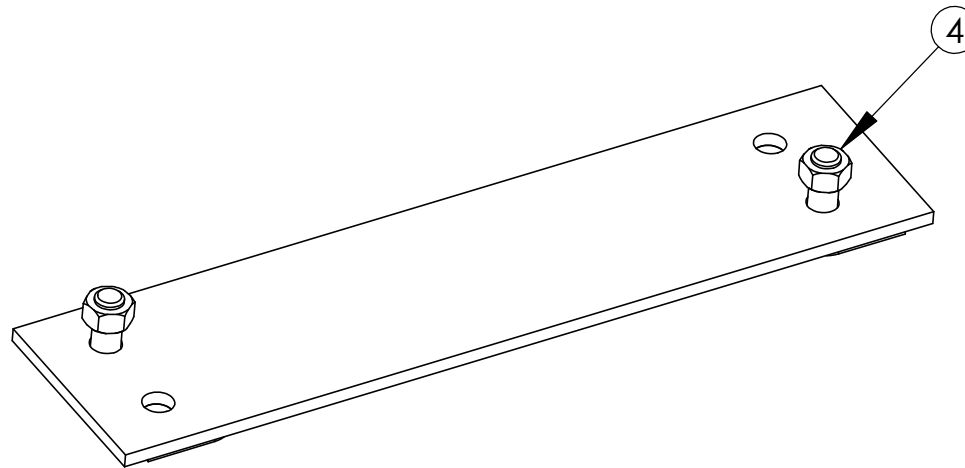
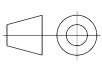
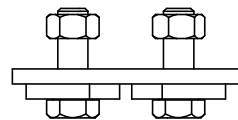
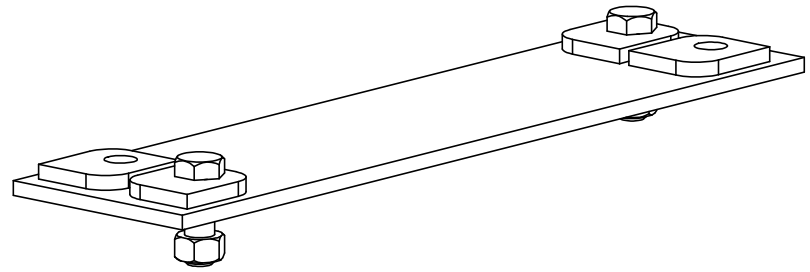
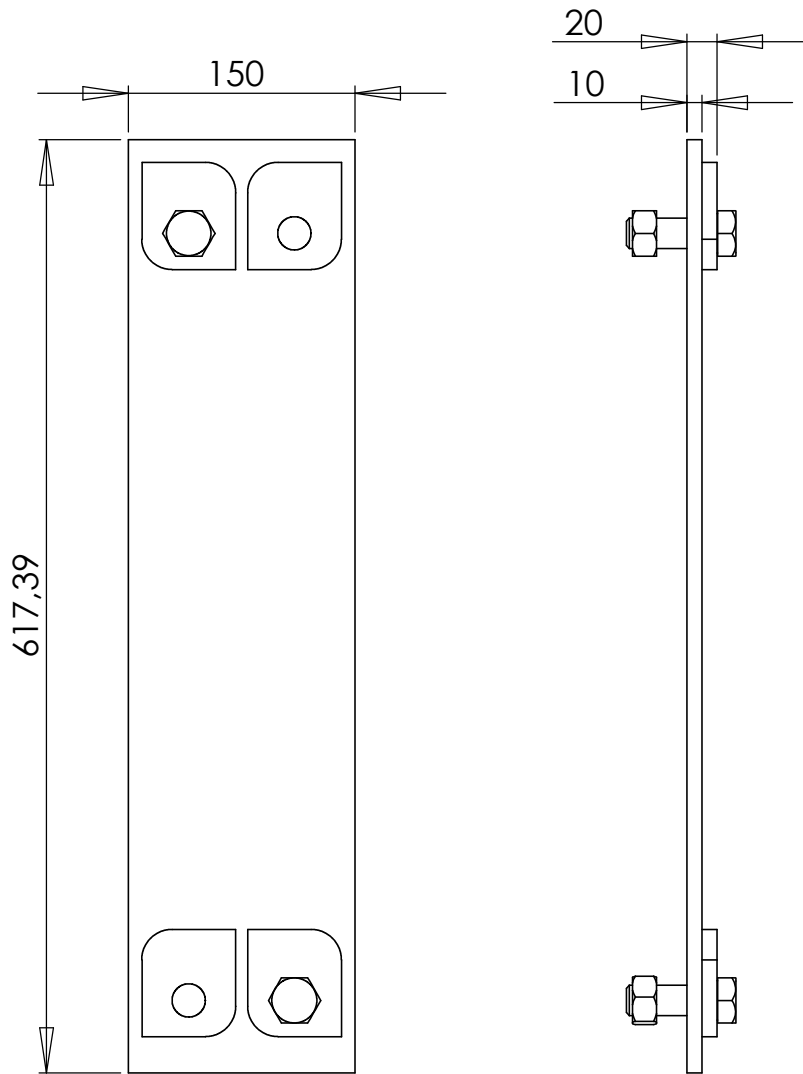

DO NOT SCALE DRAWING SHEET 2 OF 3	WEIGHT: 8955.41			<b>Rank Steel A/S</b> Industrivej 23 - 6900 Skjern - Denmark www.ranksteel.com
	DRAWN	CHECKED		
UNLESS OTHERWISE SPECIFIED: DIMENSIONS ARE IN MILLIMETERS TOLERANCES: LINEAR: According to ANGULAR: DIN 7168-g	NAME	DATE	TITLE:	
	jo	07-12-2010	Corner connector plate w. bolts (50)	
<b>PROPRIETARY AND CONFIDENTIAL</b> THE INFORMATION CONTAINED IN THIS DRAWING IS THE SOLE PROPERTY OF RANK STEEL A/S. ANY REPRODUCTION IN PART OR AS A WHOLE WITHOUT THE WRITTEN PERMISSION OF RANK STEEL A/S IS PROHIBITED.	Processes: assembly		DWG NO.	REVISION
	Remarks:		900800	4

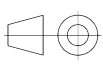

DO NOT SCALE DRAWING SHEET 3 OF 3	WEIGHT:			<b>Rank Steel A/S</b>  Industrivej 23 - 6900 Skjern - Denmark <a href="http://www.ranksteel.com">www.ranksteel.com</a>
		NAME		
UNLESS OTHERWISE SPECIFIED: DIMENSIONS ARE IN MILLIMETERS TOLERANCES: LINEAR: According to ANGULAR: DIN 7168-g	DRAWN	jo	07-12-2010	TITLE:
	CHECKED			Corner connector plate w. bolts (50)
<b>PROPRIETARY AND CONFIDENTIAL</b>  THE INFORMATION CONTAINED IN THIS DRAWING IS THE SOLE PROPERTY OF RANK STEEL A/S. ANY REPRODUCTION IN PART OR AS A WHOLE WITHOUT THE WRITTEN PERMISSION OF RANK STEEL A/S IS PROHIBITED.	Processes: assembly			DWG NO.
	Remarks:			900800