

DO NOT SCALE DRAWING SHEET 1 OF 3	WEIGHT: 11270.00		 <b>Rank Steel A/S</b> Industrivej 23 - 6900 Skjern - Denmark <a href="http://www.ranksteel.com">www.ranksteel.com</a>
	DRAWN	CHECKED	
UNLESS OTHERWISE SPECIFIED: DIMENSIONS ARE IN MILLIMETERS TOLERANCES: LINEAR: According to ANGULAR: DIN 7168-g	NAME	DATE	TITLE:
	Processes: welding shop prime		Corner connector plate w. bolts (66)
<b>PROPRIETARY AND CONFIDENTIAL</b> THE INFORMATION CONTAINED IN THIS DRAWING IS THE SOLE PROPERTY OF RANK STEEL A/S. ANY REPRODUCTION IN PART OR AS A WHOLE WITHOUT THE WRITTEN PERMISSION OF RANK STEEL A/S IS PROHIBITED.	Remarks:		DWG NO. 901650
			REVISION 0

ITEM NO.	QTY.	PART NO.	REVISION	DESCRIPTION	DIN-ISO	REMARKS
1	1	Default	0	Corner connector plate (66)		
2	4	801270	0	Bolt reinforcement		
3	2	800320	0	M20x60	DIN 933	8.8 - untreated
4	2	800350	0	M20 nut	DIN 934	8.8 - galvanized

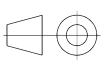

DO NOT SCALE DRAWING SHEET 2 OF 3	WEIGHT: 11270.00			<b>Rank Steel A/S</b> Industrivej 23 - 6900 Skjern - Denmark <a href="http://www.ranksteel.com">www.ranksteel.com</a>	
	UNLESS OTHERWISE SPECIFIED: DIMENSIONS ARE IN MILLIMETERS TOLERANCES: LINEAR: According to ANGULAR: DIN 7168-g			NAME jo	DATE 12-07-2010
<b>PROPRIETARY AND CONFIDENTIAL</b> THE INFORMATION CONTAINED IN THIS DRAWING IS THE SOLE PROPERTY OF RANK STEEL A/S. ANY REPRODUCTION IN PART OR AS A WHOLE WITHOUT THE WRITTEN PERMISSION OF RANK STEEL A/S IS PROHIBITED.	Processes: assembly		TITLE: Corner connector plate w. bolts (66)		
	Remarks:		DWG NO. 901650	REVISION 0	

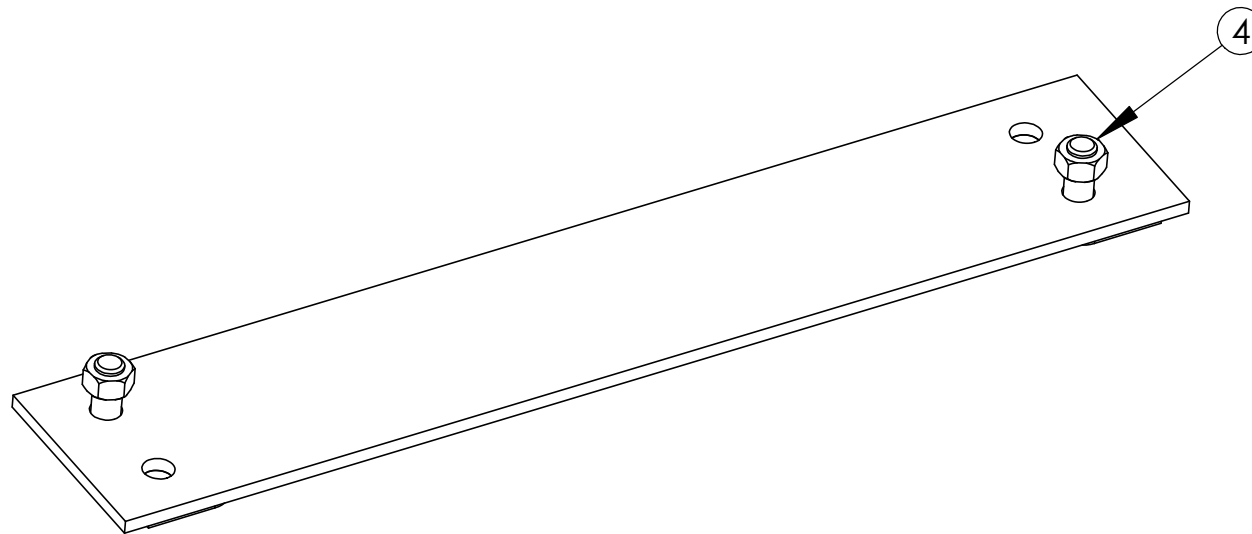
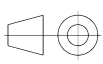
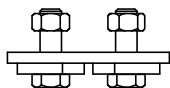
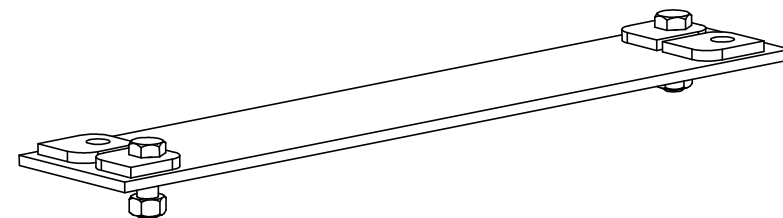
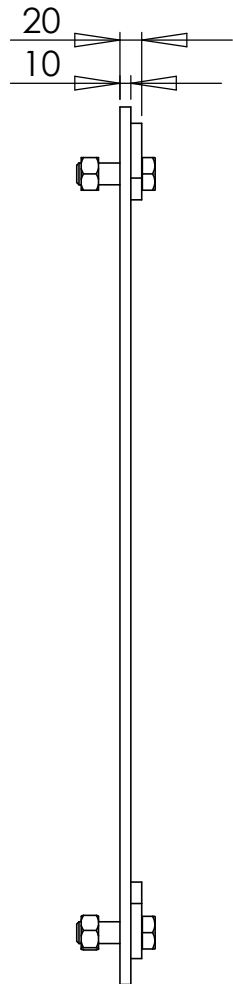
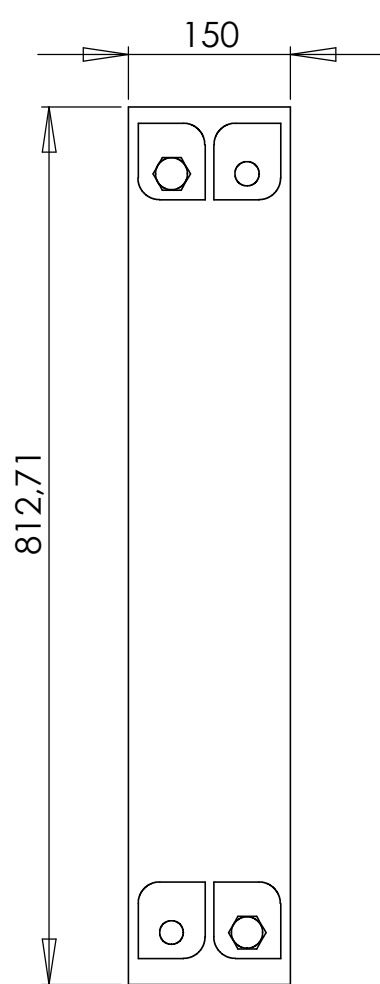

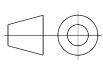
DO NOT SCALE DRAWING SHEET 3 OF 3	WEIGHT:		 <b>Rank Steel A/S</b> Industrivej 23 - 6900 Skjern - Denmark <a href="http://www.ranksteel.com">www.ranksteel.com</a>
UNLESS OTHERWISE SPECIFIED: DIMENSIONS ARE IN MILLIMETERS TOLERANCES: LINEAR: According to ANGULAR: DIN 7168-g	DRAWN	NAME jo	DATE 12-07-2010
	CHECKED		
<b>PROPRIETARY AND CONFIDENTIAL</b>  THE INFORMATION CONTAINED IN THIS DRAWING IS THE SOLE PROPERTY OF RANK STEEL A/S. ANY REPRODUCTION IN PART OR AS A WHOLE WITHOUT THE WRITTEN PERMISSION OF RANK STEEL A/S IS PROHIBITED.	Processes: assembly		TITLE: Corner connector plate w. bolts (66)
	Remarks:		DWG NO. 901650